

# Tri Technology Microwave & PIR Movement Detector with Anti-Masking

Commercial Grade, High Security Tri Technology, Microwave & PIR movement detector with 15m detection range that incorporates Anti-masking technology. The perfect choice for High Security environments where obscuration of the detectors field of view is a risk that needs to be actioned.

IR Ready, these detectors are factory fitted with an End-of-line (EOL) resistor module that is specific to Inner Range security controllers which dramatically speeds up installation time by reducing the complexity of the installation. This module is easily removed so these high quality detectors are compatible with any brand of security alarm system. High quality, highly reliable, IR Ready and easy to install, these Commercial Grade Intrusion Detectors will suit any indoor application from residential to highly sensitive commercial applications.

## Features

- Anti-masking Technology - Rest assured, our security system swiftly detects and alerts you to sensor tampering or obstruction.
- Customisable field of view – select a wide or narrow detection area by rotating the lens within the case.
- Easily Viewable LED Color - LED color is green and viewable from distance.
- Human-Catch Element - designed to create proper detection areas and optimize detection sensitivity.
- Refined Spherical Lens -provides a precise focal length to each of the multiple lens segments which enables precise detection without distortion.
- SMDA - By analysing detection patterns and environmental information, SMDA improves immunity against various noise factors such as climate changes.
- 180 Degree Cover Lock The front cover can be opened and closed by turning the captive screw lock 180 degrees with a flat head screwdriver.



## Dimensions - mm (inch)

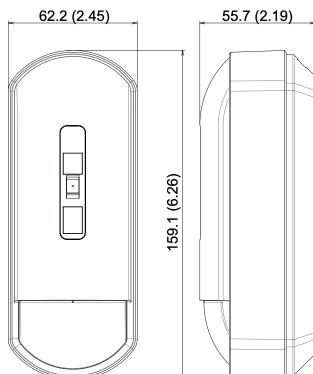

## Detection Area

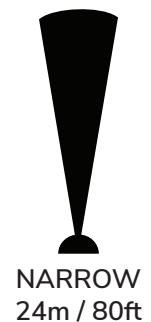
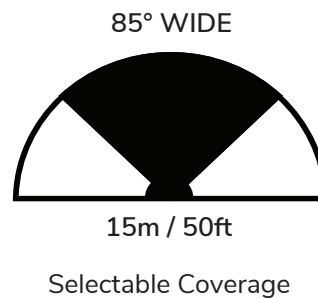

# Tri Technology Microwave & PIR Movement Detector with Anti-Masking

## Basic Features

### HUMAN CATCH ELEMENT



The new element size has been designed to create larger detection areas and optimize sensitivity whilst still eliminating alarms normally generated by small animals.

### SMDA LOGIC



By analysing detection patterns and environmental information, SMDA improves immunity against various noise factors such as climate changes and vegetation sways.

### 180 DEGREE COVER LOCK



The front cover can be opened and closed by turning the captive screw lock 180 degrees with a flat head screwdriver.

### CONFIGURABLE LENS

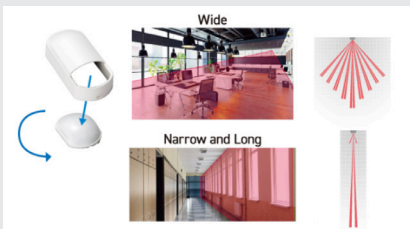

Select a wide or narrow area with one lens, simply by turning the lens upside down.

### REFINED SPHERICAL LENS

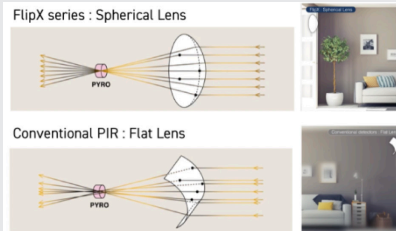

Provides a precise focal length to each of the multiple lens segments which enables precise detection without distortion.

### EASILY VIEWABLE



LED colour is green and easily viewable from a distance.

## Specific Features

### ANTI-MASKING

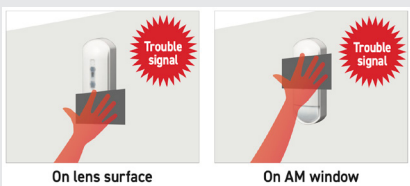

IR Anti-masking function generating a trouble signal when detector is masked.

### FITTED EOL RESISTORS

The IR Ready End-Of-Line resistor module is factory fitted and configured with the EOL's to suit the Inner Range security controllers saving significant time and money onsite.

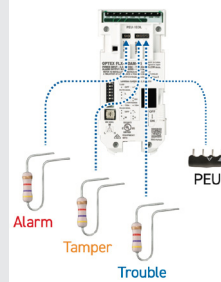

### DOWN ZONE SWITCH

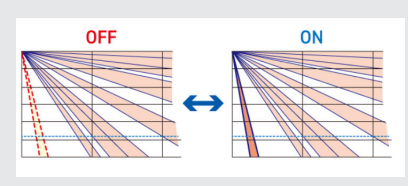

Downzone detection area is selectable "ON" or "OFF".

### REMOVABLE TERMINAL BLOCK

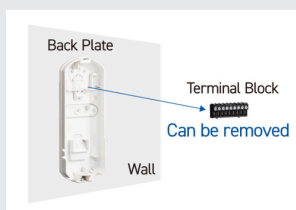

Terminal block can be removed from Back Plate for easy wiring, easy replacement of the item with no access to key parts on Main Unit.

### SUPER HIGH SENSITIVITY

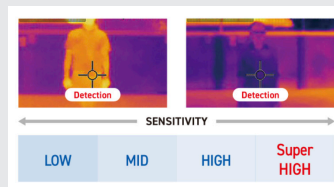

Even if temperature between human and background becomes close, Super High PIR Sensitivity can be selectable to provide far greater catch performance for the site where mis-alarm is unacceptable.

## Specifications

Part Number	IR-D-P1E	IR-D-P2E	IR-D-P3E
Model Name	COMMERCIAL PIR	COMMERCIAL DUAL-TECH	COMMERCIAL TRI-TECH
Mounting Height	2.0 to 3.0 m (6'7" to 9'8")		
Detection Method	Passive infrared	Passive infrared & Microwave	Passive infrared & Microwave
Coverage	Wide: 15 m (50') 85° Narrow: 24 m (80') 5° (MW will be stopped in "Narrow" setting)		Wide: 15 m (50 ft.) 85° Narrow: 24 m (80 ft.) 5° ( No MW detection at "Narrow" setting )
Alarm Period	2.0 ± 0.5 s		
Warm-up Period	Approx. 60 s (LED blinks)		
LED Indicator	Green: [1] Warm-up [2] Alarm		Multiple: Warm-up / Green: Alarm and Masking detection Yellow: Self test error / Red: Low voltage
Power Input	9.5 to 16 V DC		
Current Draw	8 mA (normal) 11 mA (max.) at 12 V DC	11 mA (normal) 14 mA (max.) at 12 V DC	16 mA (normal) 21 mA (max.) at 12 V DC
Relay Output	Trouble	-	N.C. 24 V DC 0.1 A max. (Resistive load)
	Alarm	N.C. 24 V DC 0.1 A max. (Resistive load)	
	Tamper	N.C. 24 V DC 0.1 A max. (Resistive load) (Open when the cover is removed)	
Remote LED	✓		
Animal Detection	Small Animal / Rodent Safe		
Operation Temperature	-20°C to +50°C (-4°F to +122°F)	-20°C to +45°C (-4°F to +113°F)	-20°C to +45°C (-4°F to +113°F)
Temperature Compensation	Digital (SMDA)		
Relative Humidity	95% RH max.		
Dimension	H: 129.2 x W: 61.5 x D: 50.9 mm (H: 5.09" x W: 2.42" x D: 2.00")		H: 159.1 mm x W: 62.2 mm x D: 55.7 mm (H: 5.09" x W: 2.42" x D: 2.00")
Weight	95 g (3.35 oz)	110 g (3.88 oz)	200 g (7.05 oz)

- Specifications and designs are subject to change without prior notice.
- These units are designed to detect an intruder and activate an alarm control panel. Being only a part of a complete system, we cannot accept responsibility for any damages or other consequences resulting from an intrusion.
- Tri models (IR-D-P3E) is certified to NF&A2P when operation temperatures are -10°C to +55°C (14°F to +131°F).

### Ordering Options



**IR-D-P3E**  
Tri Technology Passive Infrared, Microwave with Anti Mask Detector, 15m Range

### Other Models Available



**IR-D-P1E**  
Passive Infrared Detector, 15m Range



**IR-D-P2E**  
Dual Technology Passive Infrared & Microwave Detector, 15m Range



## Wiring Diagrams

### DETECTOR WIRING GUIDE

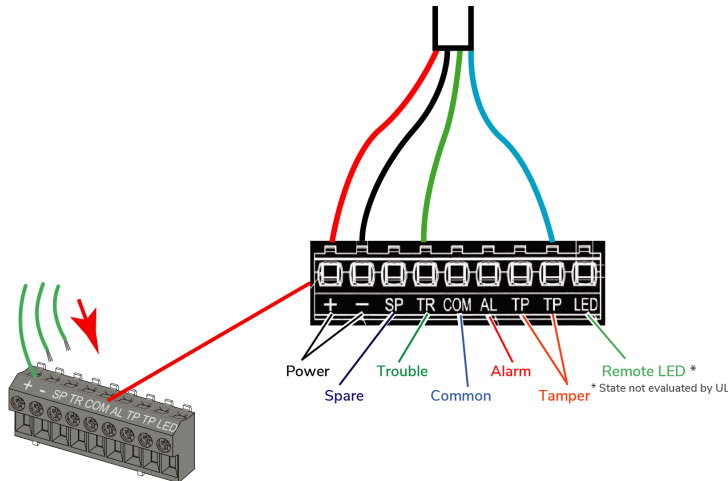

### CONTROLLER / ZONE EXPANDER WIRING GUIDE

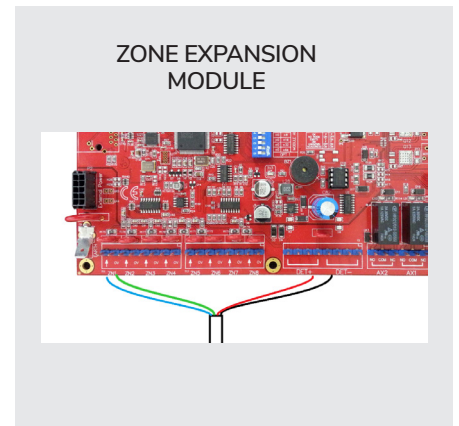
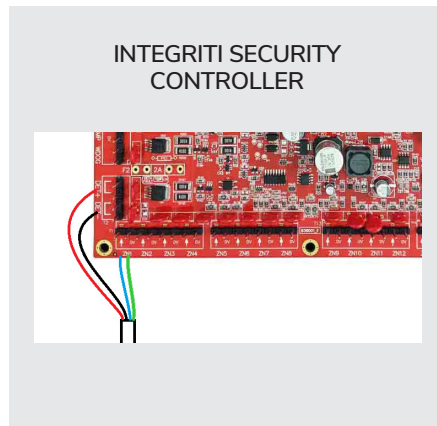
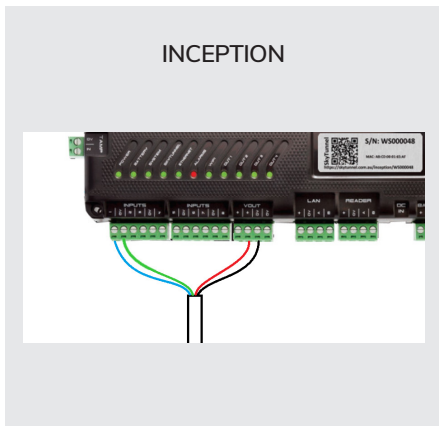

### CONTROLLER PROGRAMMING

The Inception Security Controller, the Integriti Security Controller and the Zone Expansion Modules are pre configured to have their default EOL match the IR Ready range of detectors.

NB: The Anti-masking alarm is treated as "Tamper" by the Inner Range controllers and zone expanders under the default settings. For meeting the EN50131 European standard of reporting "Mask/Trouble" by the controllers, the Inception controller needs to be set to EN50131 Compliance Mode. For Integriti, the EOL programming needs to be changed to a EN50131 version which includes the Mask/Trouble state.