



### Key Feature

- Two-pin wire for power supply and network access
- Access control function
- Noise suppression and echo cancellation
- H.264 video compression
- Low illumination
- Tampering alarm
- Fisheye camera with IR supplement light
- Supports sub-modules' access (max. 8)
- Nametag customization
- Easy to and extend

	d. EN 50130-4:2011 +A1:2014
CE-LVD	EN 60950-1:2006 + A11:2009 + A1:2010 + A12:2011 + A2:2013
CB	IEC 60950-1:2005 (Second Edition) + Am 1:2009 + Am 2:2013
FCC-SDOC	47 CFR Part 15, Subpart B
C-TICK(EMC)	AS/NZS CISPR 32:2015
UL	UL 60950-1 & CAN/CSA C22.2 No. 60950-1-07, Information Technology Equipment – Safety – Part 1: General Requirements
ROHS	2011/65/EU
REACH	Regulation (EC) No 1907/2006
WEEE	2012/19/EU

### Typical Application

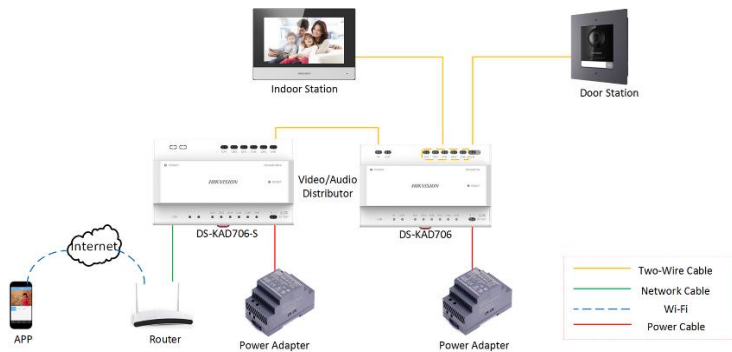

### Approval

CE-EMC	a. EN 55032:2015
	b. EN 61000-3-2:2014
	c. EN 61000-3-3:2013

## Specification

System parameters	
Processor	Embedded MCU Processor
Operation system	Embedded Linux operation system
Operation method	Physical button
Video Parameters	
Camera	Low illumination 2 MP HD IR camera
Video Compression Standard	H.264
Resolution	Main stream : 1920 × 1080 Sub stream : 720 × 480
Video stream	Main stream: 1080p@30fps, 720p@30fps (configurable); sub stream: D1
BLC	Supported
DNR	Supported
WDR	Supported
Anti-flicker	50 Hz, 60 Hz
Field of view	Horizontal: 180° Vertical: 96°
Motion detection	Supported
Audio parameters	
Audio intercom	Full-duplex two-way audio intercom
Audio input	Built-in omnidirectional microphone
Audio output	Built-in loudspeaker (More than 85 dB within 20 cm)
Audio compression standard	G.711 U
Audio compression Rate	64 Kbps
Audio quality	Noise suppression and echo cancellation
Light supplement	
Light supplement mode	IR supplement
Network parameters	
Wired network interface	Two-wire transmission
Network protocol	TCP/IP, RSTP
Access control	
Relay interface (main module)	2, NO + NC separately draw forth
Interfaces	
Module-connecting	1
Tampering alarm	1
Alarm input	4
Performances	
Card capacity	Max. 10000
User capacity	Max. 2000
Linked Indoor station	Max. 100

Linked sub door station	Max. 8
Linked doorphone	Max. 8
Protocol	ISAPI, RTSP, STMP, SNMP
Unlock door	Unlock by presenting cards, unlock via Client Software, unlock via App, unlock via indoor station

General	
Physical button	1
Protection level	IP 65
Power input	24 VDC two-wire power supply (< 16 W) or 12 VDC independent power supply (< 20 W)
Power output	12 VDC (only for power supply of submodule)
Working temperature	-40° C to +60° C (-40° F to 140° F)
Working humidity	10% to 95%
Installation	Flush mounting, surface mounting
Dimension	98 mm × 99.8 mm × 43.9 mm (3.86" × 3.93" × 1.73")
Material	Stainless steel

## Available Model

DS-KD8003-IME2/S

## Appearance and Interfaces

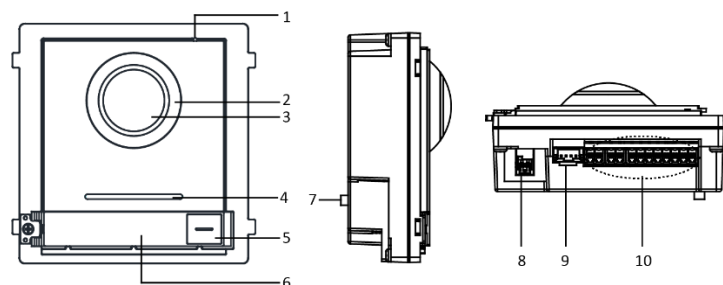

No.	Description	No.	Description
1	Microphone	6	Nametag
2	Low Illumination IR Supplement Light	7	TAMPER
3	Built-in Camera	8	Network Interface and Power Supply
4	Loudspeaker	9	Module-connecting Interface (output)
5	Call Button	10	Terminals

**Dimension**

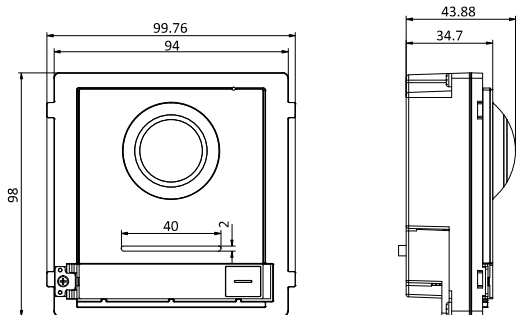

DS-KD-ACF3/S



DS-KD-ACW1/S

**Accessory**

**Optional**



DS-KD-ACF1/Plastic

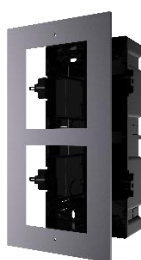

DS-KD-ACF2/Plastic

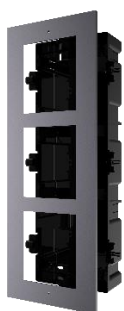

DS-KD-ACF3/Plastic

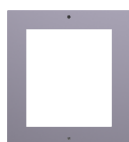

DS-KD-ACW1



DS-KD-ACW2



DS-KD-ACW3



DS-KD-ACF1/S

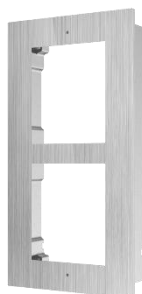

DS-KD-ACF2/S



DS-KD-ACW2/S



DS-KD-ACW3/S

Distributed by

**HIKVISION®****Headquarters**

No.555 Qianmo Road, Binjiang District,  
Hangzhou 310051, China  
T +86-571-8807-5998  
overseasbusiness@hikvision.com

**Hikvision USA**  
T +1-909-895-0400  
sales.usa@hikvision.com

**Hikvision Australia**  
T +61-2-8599-4233  
salesau@hikvision.com

**Hikvision India**  
T +91-22-28469900  
sales@pramahikvision.com

**Hikvision Canada**  
T +1-866-200-6690  
sales.canada@hikvision.com

**Hikvision Thailand**  
T +662-275-9949  
sales.thailand@hikvision.com

**Hikvision Europe**  
T +31-23-5542770  
sales.eu@hikvision.com

**Hikvision Italy**  
T +39-0438-6902  
info.it@hikvision.com

**Hikvision Brazil**  
T +55 11 3318-0050  
Latam.support@hikvision.com

**Hikvision Turkey**  
T +90 (216)521 7070- 7074  
sales.tr@hikvision.com

**Hikvision Malaysia**  
T +601-7652-2413  
sales.my@hikvision.com

**Hikvision UK & Ireland**  
T +01628-902140  
sales.uk@hikvision.com

**Hikvision South Africa**  
Tel: +27 (10) 0351172  
sale.africa@hikvision.com

**Hikvision France**  
T +33(0)1-85-330-450  
info.fr@hikvision.com

**Hikvision Kazakhstan**  
T +7-727-9730667  
nikia.panfilov@hikvision.ru

**Hikvision Vietnam**  
T +84-974270888  
sales.vt@hikvision.com

**Hikvision UAE**  
T +971-4-4432090  
salesme@hikvision.com

**Hikvision Singapore**  
T +65-6684-4718  
sg@hikvision.com

**Hikvision Spain**  
T +34-91-737-16-55  
info.es@hikvision.com

**Hikvision Tashkent**  
T +99-87-1238-9438  
uzb@hikvision.ru

**Hikvision Hong Kong**  
T +852-2151-1761  
info.hk@hikvision.com

**Hikvision Russia**  
T +7-495-669-67-99  
saleru@hikvision.com

**Hikvision Korea**  
T +82-(0)31-731-8817  
sales.korea@hikvision.com

**Hikvision Poland**  
T +48-22-460-01-50  
info.pl@hikvision.com

**Hikvision Indonesia**  
T +62-21-2933759  
Sales.Indonesia@hikvision.com

**Hikvision Colombia**  
sales.colombia@hikvision.com